



IZI
Estruturas



17 3283-2018

MANUAL DE MONTAGEM
ESTRUTURA PARA LAJE

KIT ESTRUTURA PARA LAJE

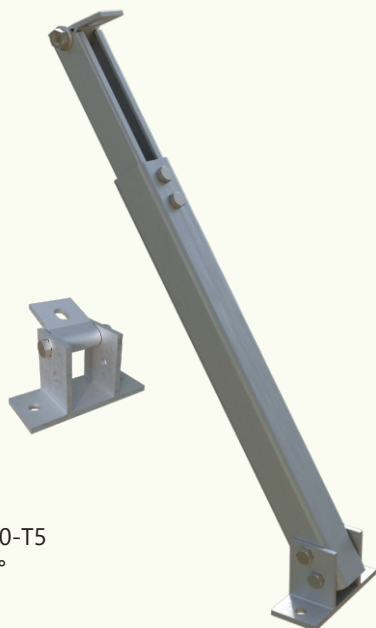

KIT SUPORTE

COD.: IZI650

Material: Alumínio 6060-T5

Inclinação: de 15° a 25°

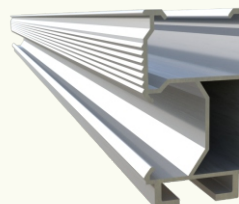

PERFIL C REFORÇADO

COD.: IZI009

Material: Alumínio 6060-T5

Distância máx. entre apoios: 2,00m

Tamanho disponível: 2,40m - 4,50m - 4,80m

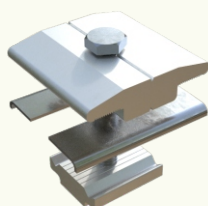

GRAMPO INTERMEDIÁRIO

COD.: IZI 200

Material: Alumínio 6005-T5 | Inox 304

Altura: 30 à 40mm

Acompanha: Parafuso Sextavado inox, porca de alumínio e chapa de contato de inox (para aterramento)

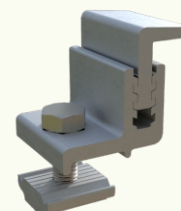

GRAMPO FINAL

COD.: IZI 201

Material: Alumínio 6005-T5 | Inox 304

Altura: 30 à 40mm

Acompanha: Parafuso Sextavado inox e porca de alumínio.



PARAFUSO PARABOLT

Material: Aço Inox 304 e Galvanizado.

Quantidade: 4 peças



PARAFUSO CABEÇA MARTELO

Material: Aço Inox 304.

Dimensões: M10x25.

Quantidade: 2 Peças



PORCA SEXTAVADA

Material: Aço Inox 304.

Dimensões: M10

Quantidade: 5 Peças

MONTAGEM PASSO A PASSO

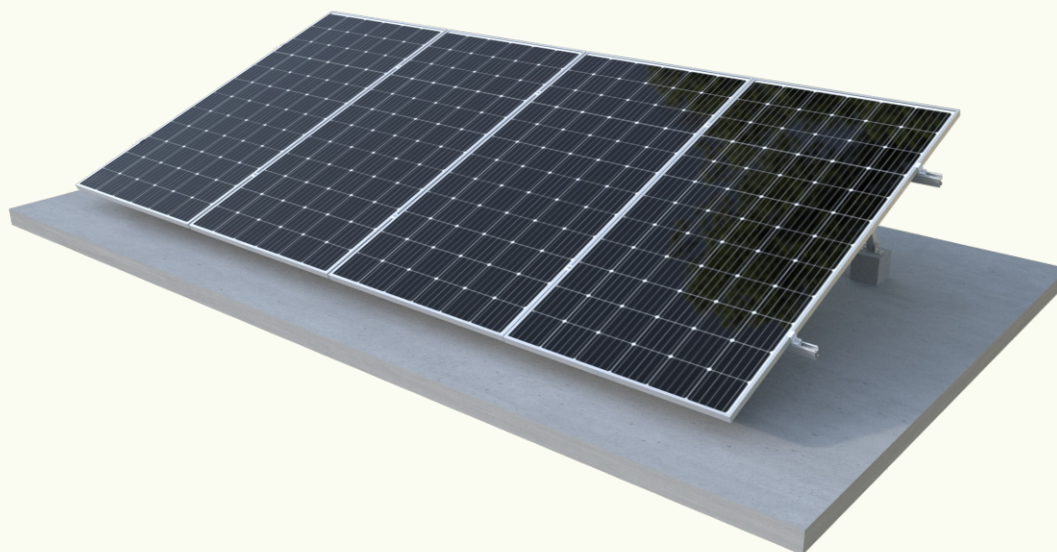

- Preparar a laje com sapatas para escoramento do suporte, com o distanciamento conforme os desenhos abaixo.

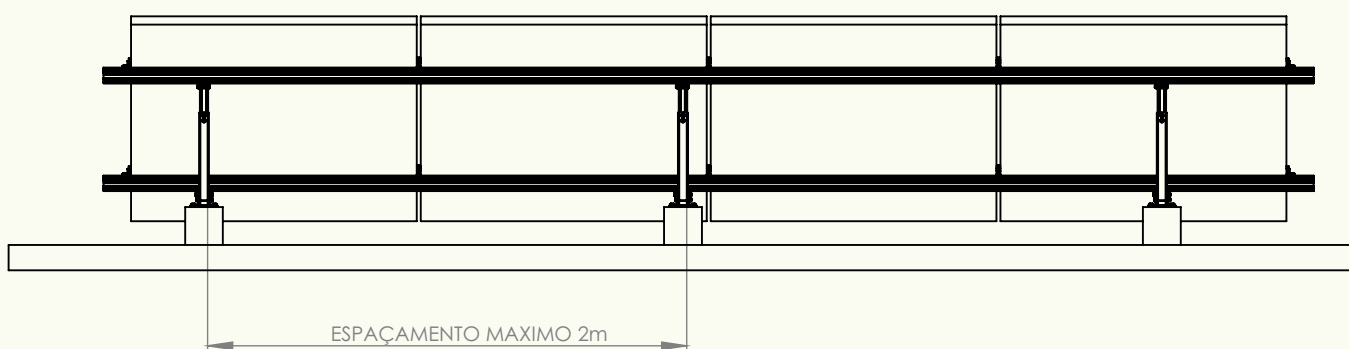
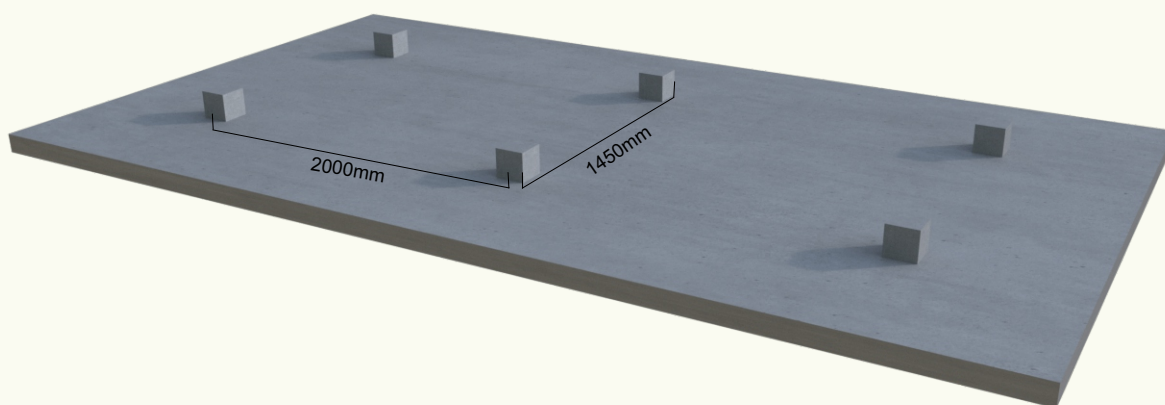
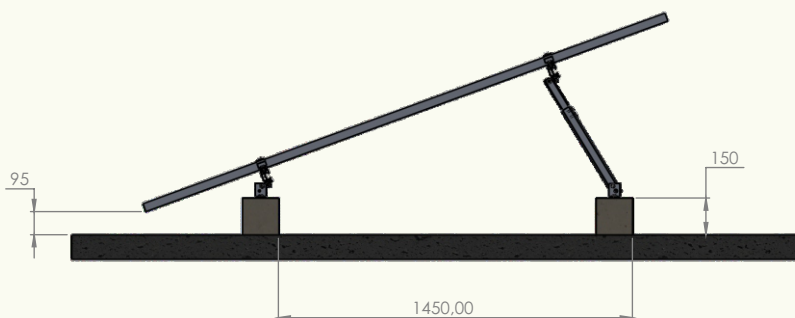

MONTAGEM PASSO A PASSO

- Fixar os suportes nas sapatas com parabolts.

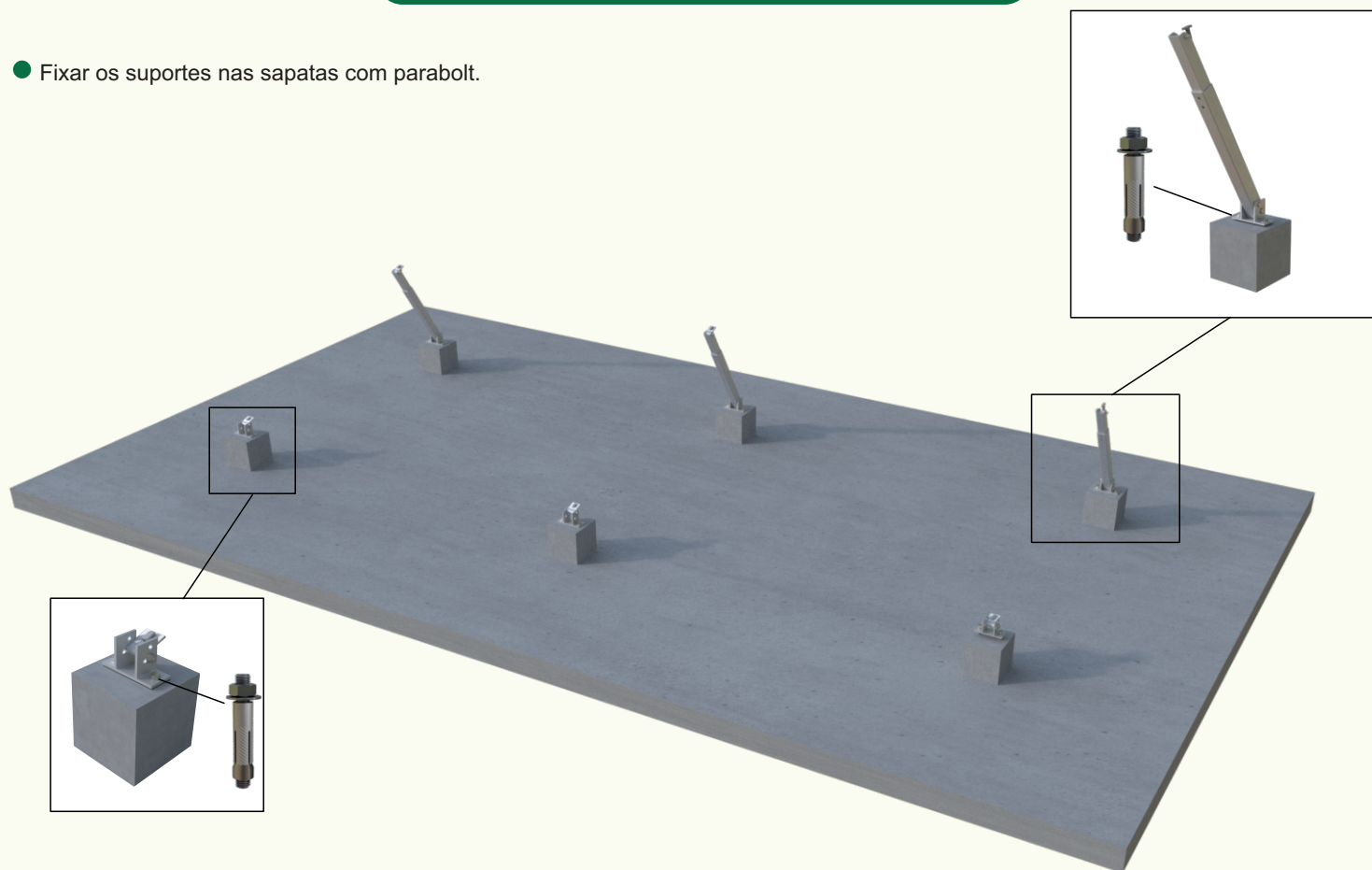

- Fixar os perfis no suporte com parafuso cabeça de martelo M10x25.

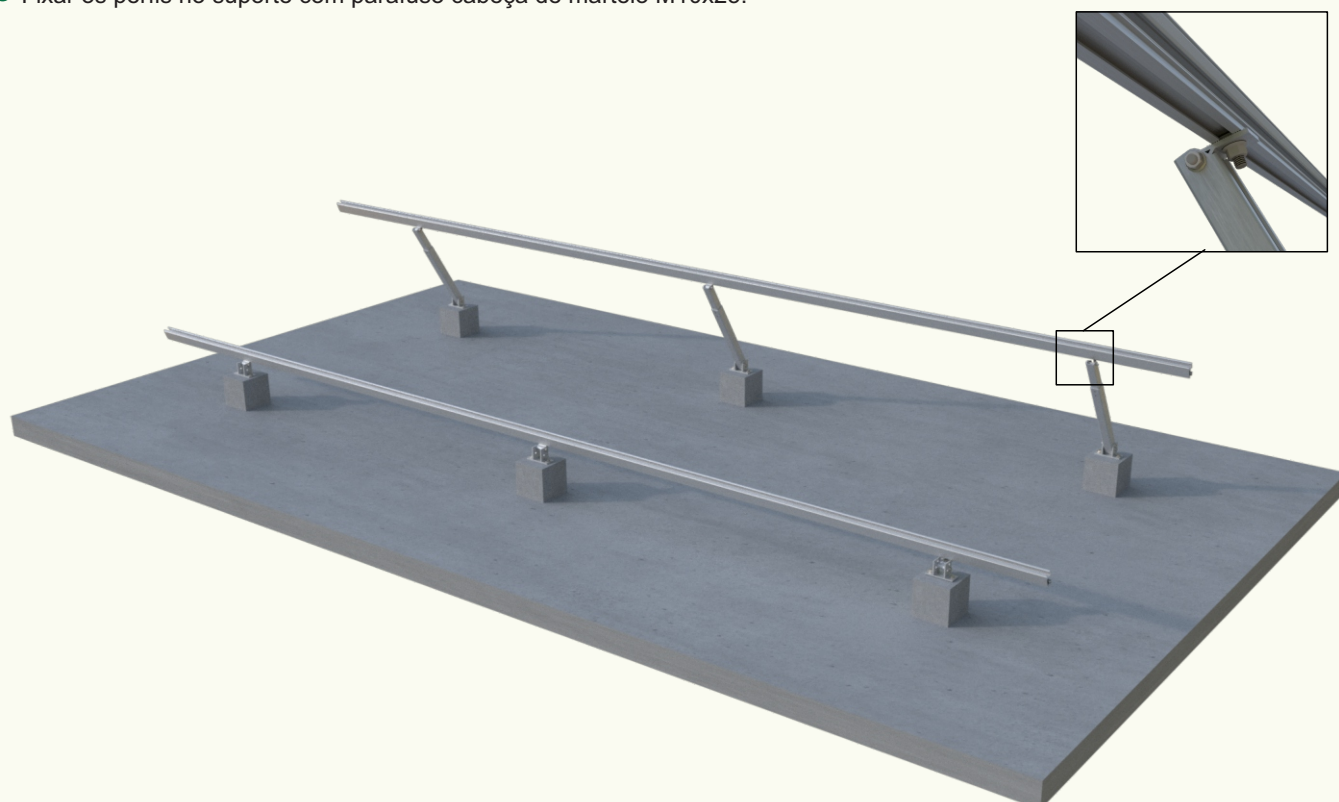

FIXAÇÃO GRAMPO FINAL

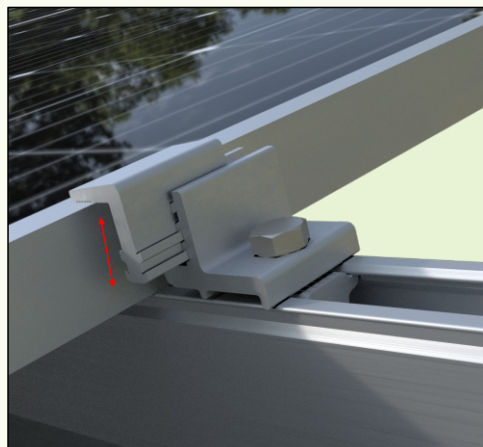

- Grampo final com regulagem para módulos de 30mm a 40mm de altura.

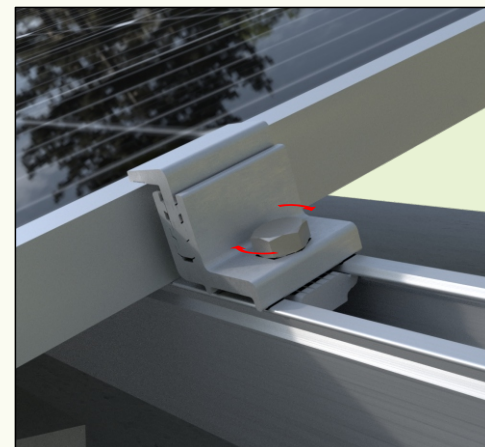
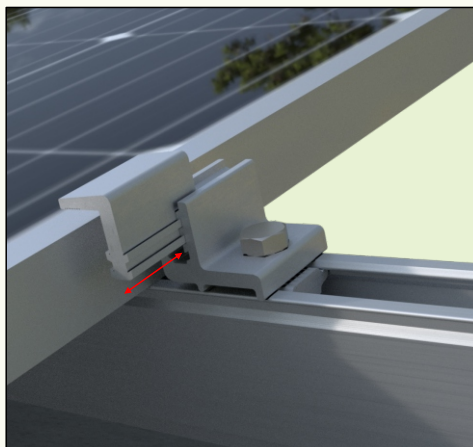

- Após regular a altura do grampo com a altura do módulo fixar o parafuso.

FIXAÇÃO GRAMPO INTERMEDIÁRIO

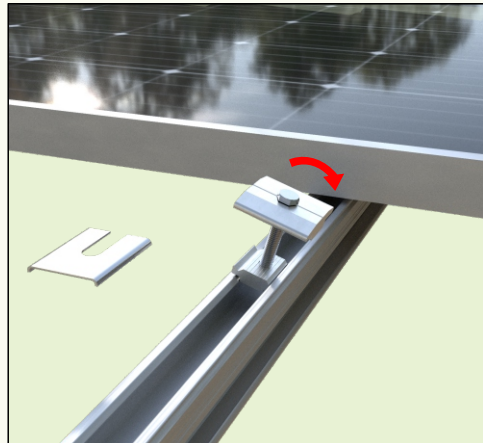

- Girar o grampo intermediário levemente para se encaixar no perfil C.

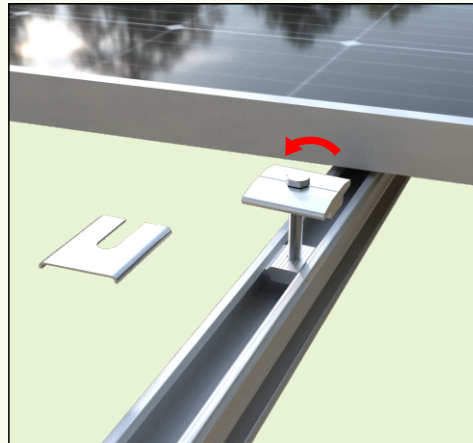

- Após ser encaixado empurrar até o módulo já posicionado, sem apertar.

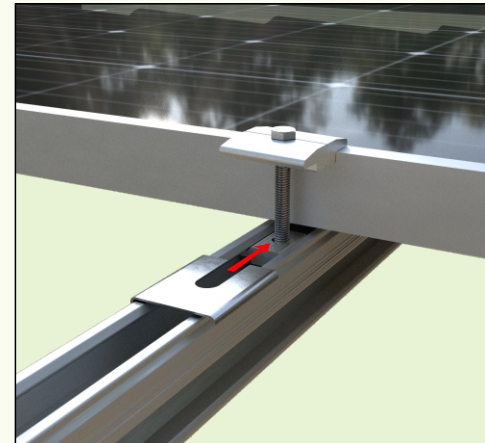

- Colocar a chapa de aterramento sob o módulo.

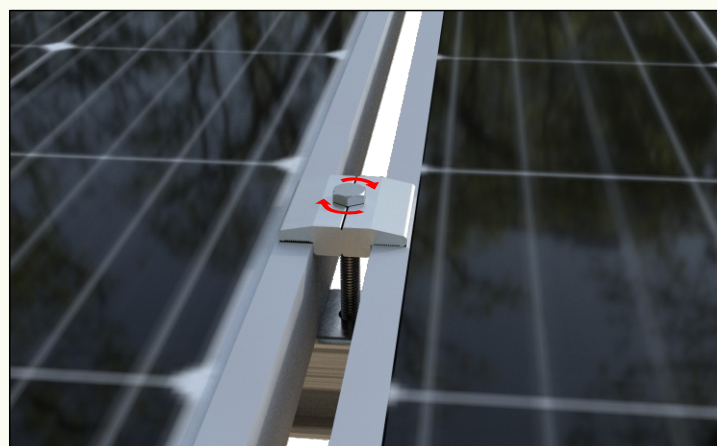

- Fixar o grampo intermediário com parafuso sextavado de inox.



Izi Industrial LTDA
www.iziestrutas.com.br

 @iziestrutas

 17 3283-2018